

# CMI-MMP4020QL-SERIES

## Features

- ▶ Low profile, Compact design.
- ▶ Metal powder molding type for EMC protection.
- ▶ Available tape and reel for auto insertion.
- ▶ Halogen-Free / RoHS compliant.

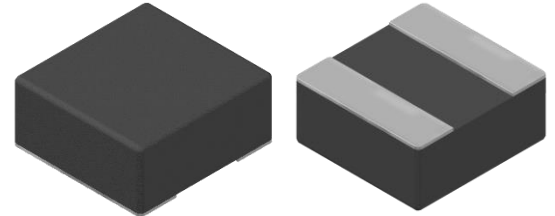

## Applications

- ▶ For DC/DC converter, AV equipment digital consumer electronics

Dimension (Unit:mm)

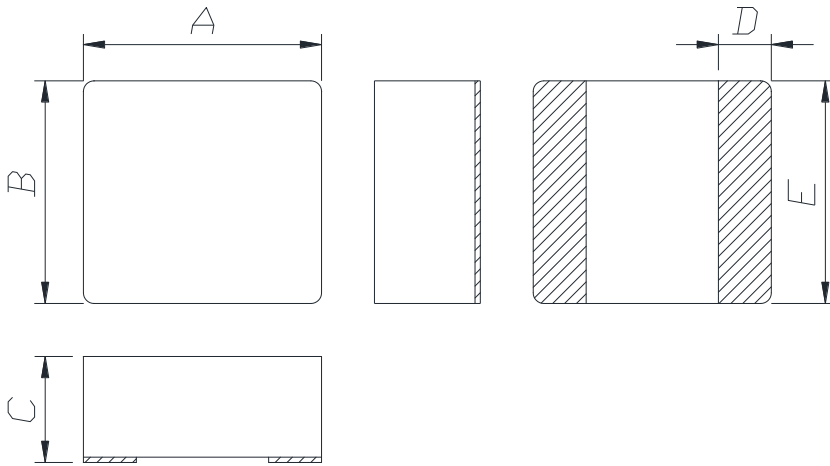

A	B	C	D	E
4.5±0.3	4.2±0.3	2.0 Max.	1.0±0.3	4.2±0.3

Land Pattern (Unit:mm)

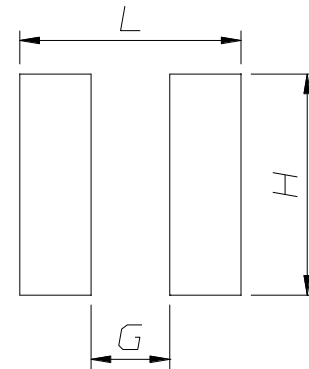

L	G	H
4.5	1.6	4.3

## Regulation of part number

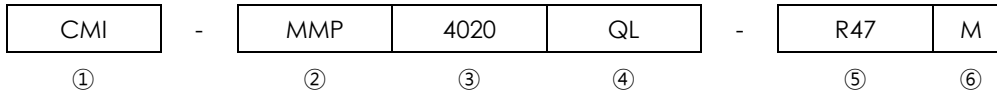

- ① CoilMaster's initial
- ② Series Name : Metal Molded Power inductor
- ③ Core Size (unit:mm)
- ④ Type
- ⑤ Typical inductance value (0.47uH)
- ⑥ Inductance tolerance ( $\pm 20\%$ )

## Specifications

Part Number	Inductance (uH) $\pm 20\%$	DCR(mohm) Max.(Typ.)	Isat(A) Max.(Typ.)	Itemp(A) Max.(Typ.)	Test Frequency (Hz)
CMI-MMP4020QL-R47M	0.47	6.6(5.5)	10.5(11.5)	9.5(10.0)	2M
CMI-MMP4020QL-1R0M	1.0	12(10)	9.0(10.0)	8.0(8.5)	2M

- Isat: When based on the inductance change rate (approximately 30% below in the initial value)
- Itemp: When based on the temperature increase (Temperature increase of approximately 40°C by self heating)
- Operating Temperature Range(including self temperature) : -40°C ~ +125 °C

Note 1 : Circuit design, component placement, PCB trace size and thickness, airflow and other cooling. Provision all affect the part Temperature. Part temperature should be verified in the end application.

## Electrical characteristics

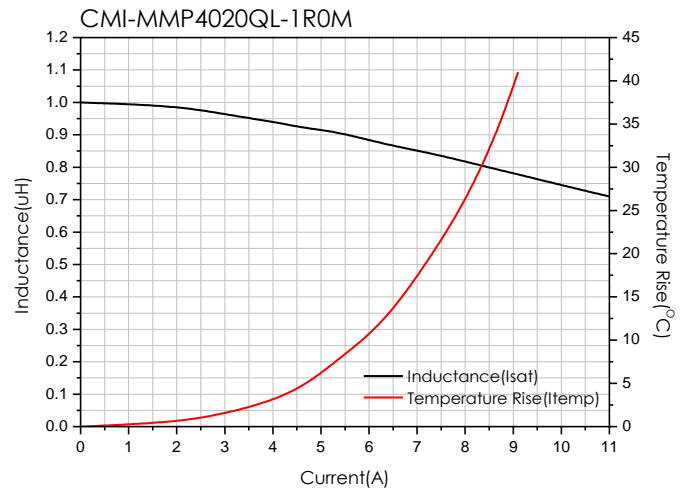
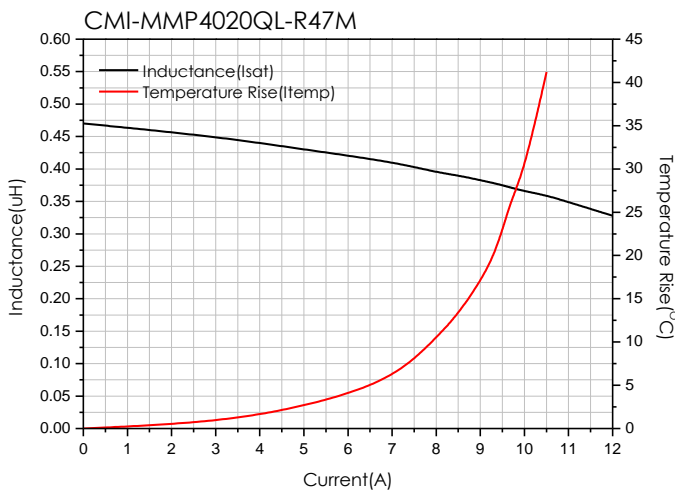

- You can also contact us by e-mail : [coilmaster@coilmaster.com](mailto:coilmaster@coilmaster.com)
- All specifications are subject to change without notice.
- Update date : 2023.05.10

## Packaging

(1) Package quantity : 3,000 (pcs/reel)

(2) Reel Dimensions (unit:mm)



A	B	C	D	E	F	G
12.50	100.0	2.00	330.0	1.90	21.00	13.00
+1.00	+1.50	+0.10	+1.00	+0.40	+0.40	+0.40
-1.00	-1.50	-0.10	-1.00	-0.40	-0.40	-0.40

(3) Tape Dimensions

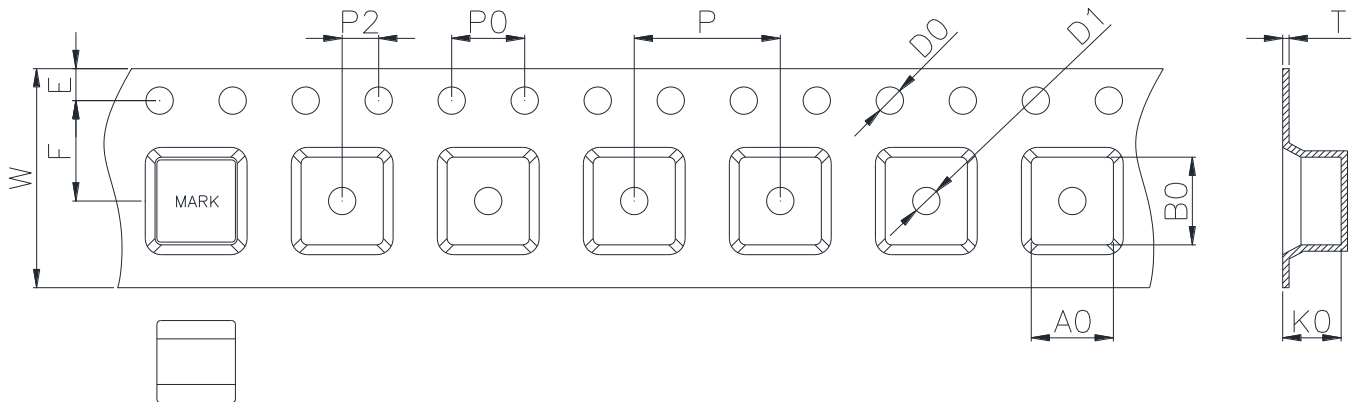

W	A0	B0	K0	E	F	P	P0	P2	D0/D1	T
12.00	4.60	4.90	2.20	1.75	5.50	8.00	4.00	2.00	1.50	0.35
+0.30	+0.10	+0.10	+0.10	+0.15	+0.10	+0.10	+0.10	+0.10	+0.10	+0.05
-0.10	-0.10	-0.10	-0.10	-0.10	-0.10	-0.10	-0.10	-0.10	-0.00	-0.05

Korea Sales Office (KOREA) +82)31-904-1444  
 China Sales Office (CHINA) +86)0758-683-1444  
 Hungary Sales office (EUROPE) +36)1-404-5832

H.K Sales Office (HONGKONG) +852)2711-5551  
 LA Sales Office (USA) +1)714-616-6989

• You can also contact us by e-mail : [coilmaster@coilmaster.com](mailto:coilmaster@coilmaster.com)

- All specifications are subject to change without notice.
- Update date : 2023.05.10

[www.coilmaster.com](http://www.coilmaster.com)