

# CMI-CMMPP13090LH-SERIES

## Features

- ▶ High current and low profile
- ▶ Metal powder molding type for EMC protection.
- ▶ Available tape and reel for auto insertion.
- ▶ Halogen-Free / RoHS compliant.
- ▶ AEC-Q200 qualified.

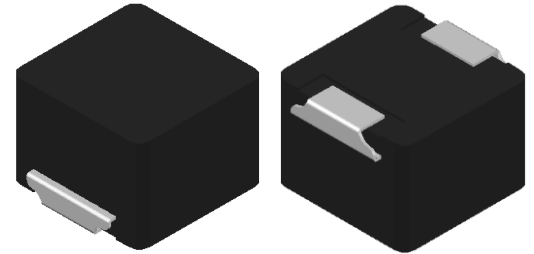

## Applications

- ▶ Equipment using for automobiles (ECM, Airbags, Headlights, Electronic Power steering, Motors, ABS, other)

### Dimension (Unit:mm)

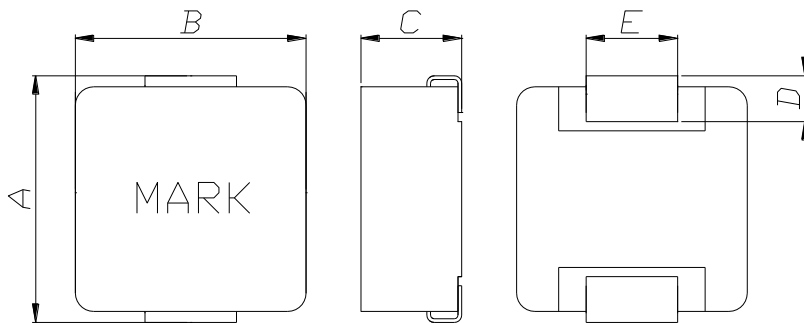

A	B	C	D	E
13.65±0.5	12.6±0.4	9.0 Max	2.5±0.5	5.0±0.2

### Land Pattern (Unit:mm)

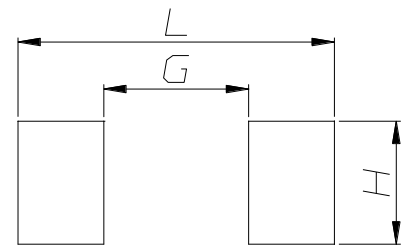

L	G	H
15.0	7.0	5.5

## Regulation of part number

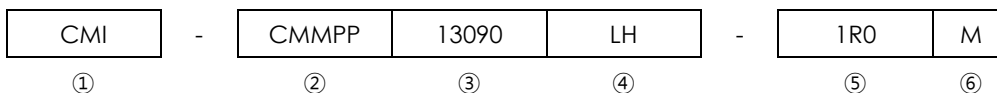

- ① CoilMaster's initial
- ② Series Name : Car Magic Material Pin type Power inductor
- ③ Core Size (unit:mm)
- ④ Material
- ⑤ Typical inductance value (1.0uH)
- ⑥ Inductance tolerance (±20%)

• You can also contact us by e-mail : [coilmaster@coilmaster.com](mailto:coilmaster@coilmaster.com)  
 • All specifications are subject to change without notice.  
 • Update date : 2020.09.26

## Specifications

Part Number	Inductance (uH) $\pm 20\%$	DCR(mohm) Max.(Typ.)	IDC1(A) Max.(Typ.)	IDC2(A) Max.(Typ.)	Test Frequency (Hz)
CMI-CMMPP13090LH-1R0M	1.0	1.8(1.5)	50.00(55.00)	35.00(38.00)	1M
CMI-CMMPP13090LH-1R2M	1.2	2.8(2.5)	40.00(45.00)	34.00(36.00)	1M
CMI-CMMPP13090LH-2R2M	2.2	4.2(3.6)	32.00(37.00)	28.00(30.00)	1M
CMI-CMMPP13090LH-3R3M	3.3	5.4(4.5)	30.00(35.00)	25.00(28.00)	1M
CMI-CMMPP13090LH-4R7M	4.7	7.8(6.5)	28.00(33.00)	19.50(21.50)	1M
CMI-CMMPP13090LH-6R8M	6.8	13.4(11.2)	19.00(22.00)	17.50(18.00)	1M
CMI-CMMPP13090LH-470M	47	73.2(61.0)	8.00(8.50)	7.00(7.50)	1M

- IDC1: When based on the inductance change rate (approximately 30% below in the initial value)
- IDC2: When based on the temperature increase (Temperature increase of approximately 40°C by self heating)
- Operating Temperature Range(including self temperature) : -40°C ~ +165 °C

Note 1 : Circuit design, component placement, PCB trace size and thickness, airflow and other cooling. Provision all affect the part Temperature. Part temperature should be verified in the end application.

## Electrical characteristics

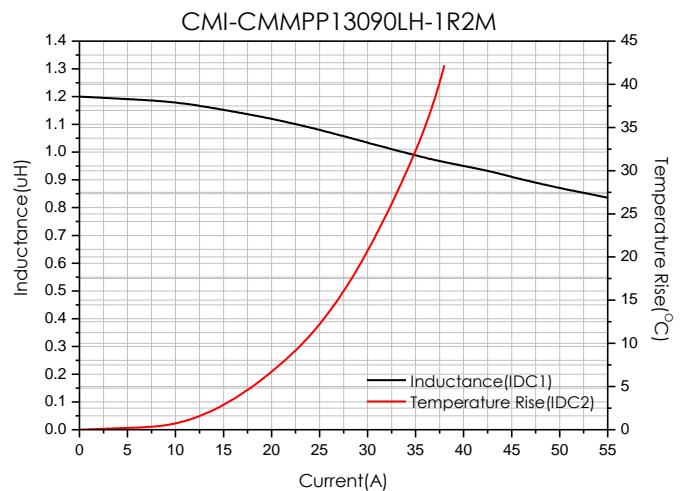
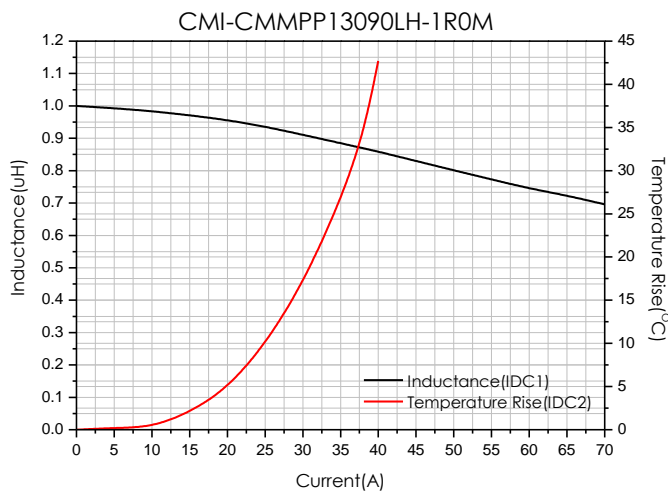

- You can also contact us by e-mail : [coilmaster@coilmaster.com](mailto:coilmaster@coilmaster.com)
- All specifications are subject to change without notice.
- Update date : 2020.09.26

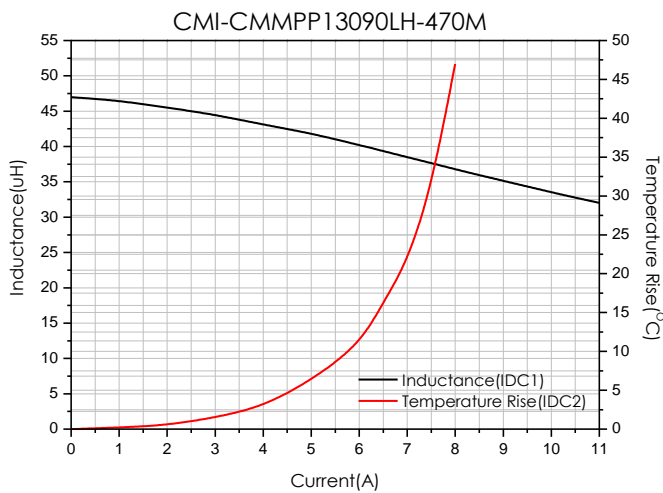
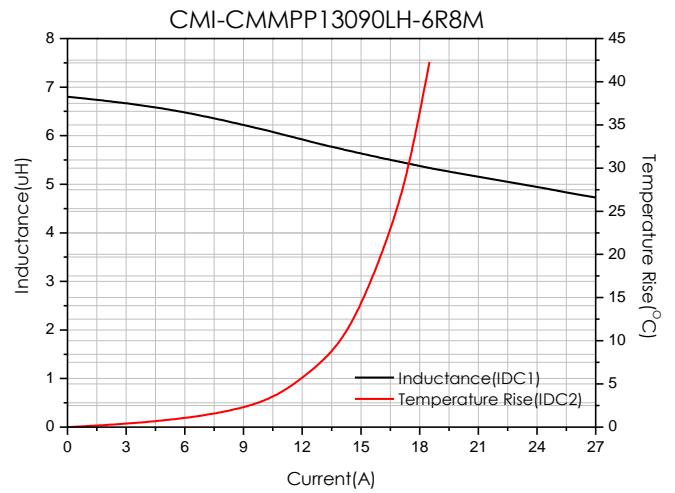
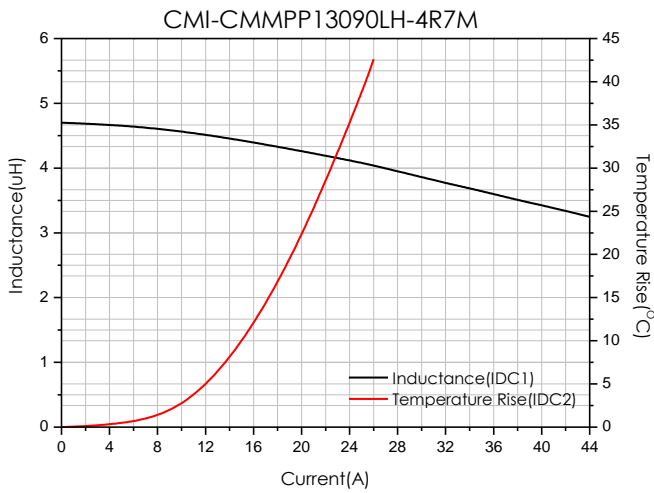
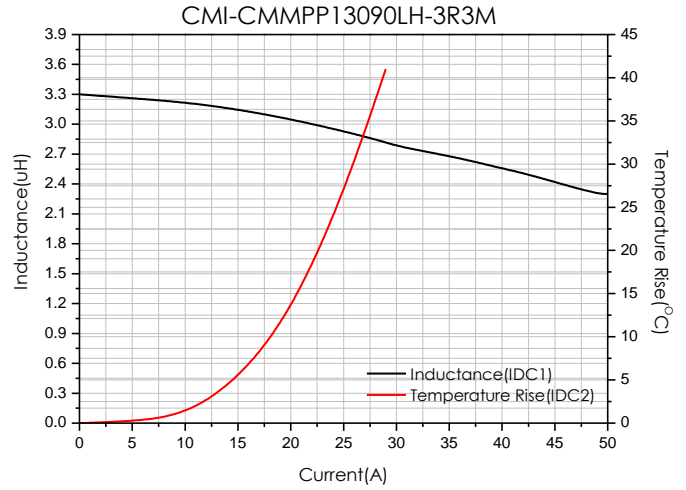
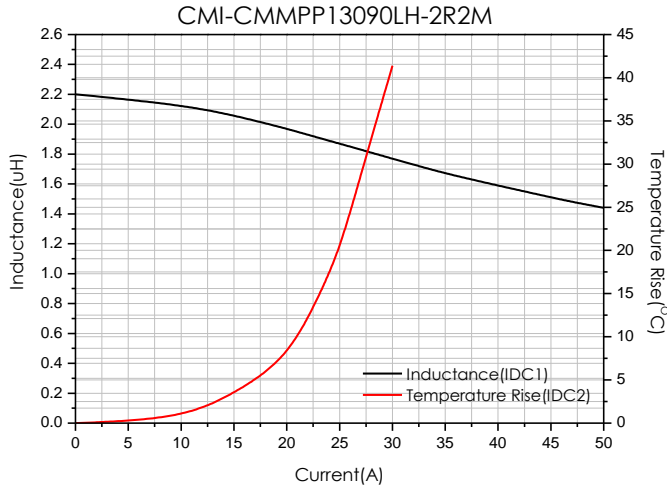

- You can also contact us by e-mail : [coilmaster@coilmaster.com](mailto:coilmaster@coilmaster.com)
- All specifications are subject to change without notice.
- Update date : 2020.09.26

## Packaging

(1) Package quantity : 300 (pcs/reel)

(2) Reel Dimensions (unit:mm)

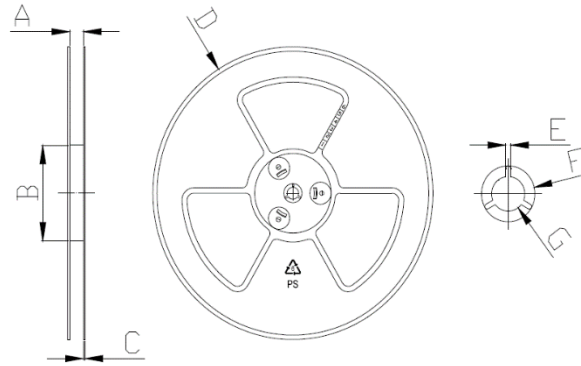

A	B	C	D	E	F	G
24.50	100.0	2.30	330.0	2.30	21.50	13.00
+0.50	+1.00	+0.20	+3.00	+0.30	+0.30	+0.50
-0.50	-1.00	-0.20	-3.00	-0.30	-0.30	-0.20

(3) Tape Dimensions

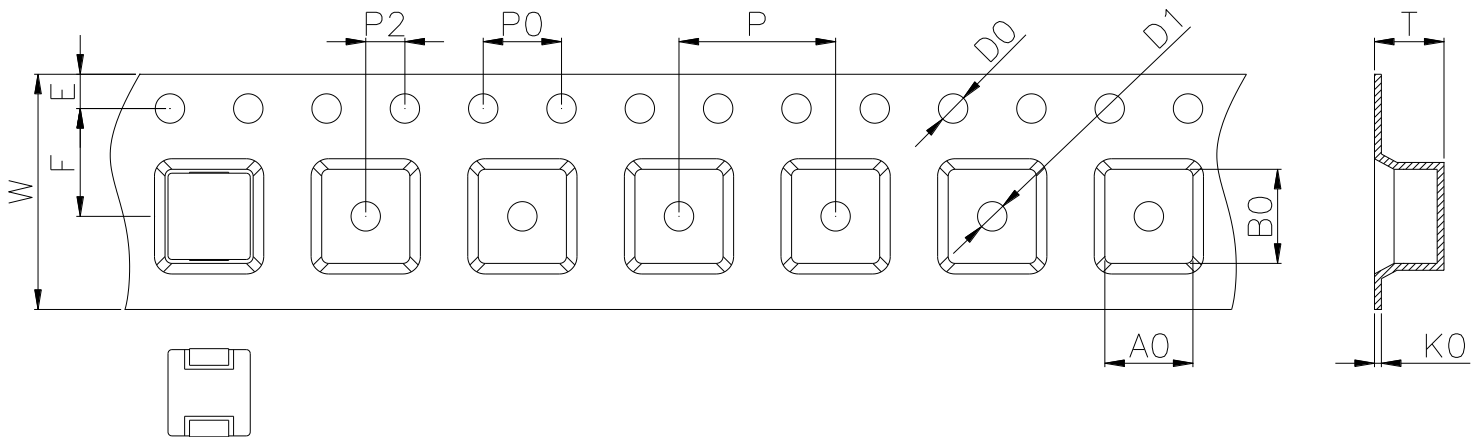

W	A0	B0	K0	E	F	P	P0	P2	D0/D1	T
24.00	13.00	14.20	9.10	1.75	11.50	20.00	4.00	2.00	1.50	0.50
+0.30	+0.10	+0.10	+0.15	+0.10	+0.10	+0.10	+0.10	+0.10	+0.10	+0.05
-0.10	-0.10	-0.10	-0.10	-0.10	-0.10	-0.10	-0.10	-0.10	-0.00	-0.05

Ilisan Sales Office (KOREA) +82)31-904-1444  
 China Sales Office (CHINA) +86)758-278-7031  
 Hungary Sales office (EUROPE) +36)1-899-8543

H.K Sales Office (HONGKONG) +852)2711-5551  
 LA Sales Office (USA) +1)866-446-3586

• You can also contact us by e-mail : [coilmaster@coilmaster.com](mailto:coilmaster@coilmaster.com)

- All specifications are subject to change without notice.
- Update date : 2020.09.26

[www.coilmaster.com](http://www.coilmaster.com)