

CMI-CMMP5030HL-A SERIES

Features

- ▶ High Current, Compact design.
- ▶ Metal powder molding type for EMC protection.
- ▶ Available tape and reel for auto insertion.
- ▶ Halogen-Free / RoHS compliant.
- ▶ AEC-Q200 qualified.

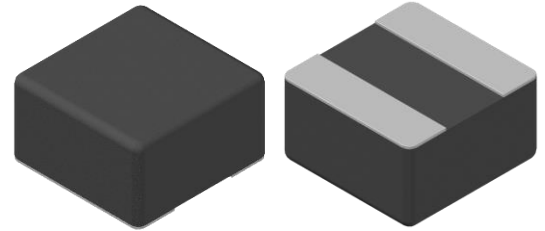

Applications

- ▶ Car navigation, Car stereo and Car accessories, ADAS ECU, In-C-Vehicle camera (View camera, Sensing camera), Automotive communication module.

Dimension (Unit:mm)

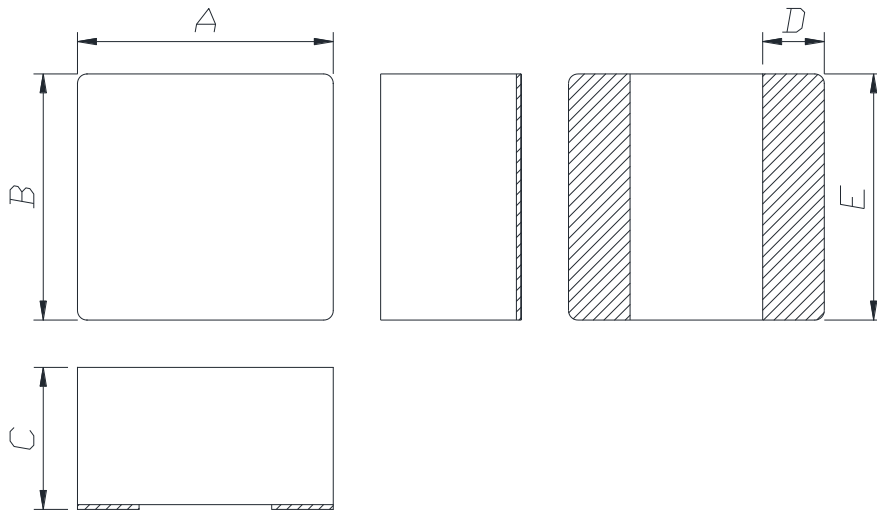

A	B	C	D	E
5.4±0.3	5.2±0.3	3.0 Max.	1.3±0.3	5.2±0.3

Land Pattern (Unit:mm)

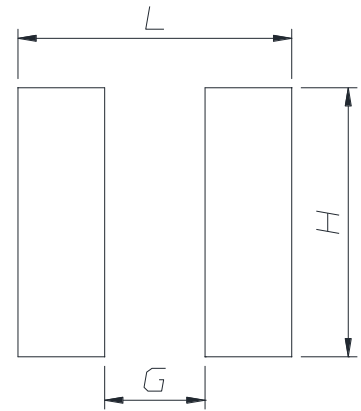

L	G	H
6.0	2.2	5.9

Regulation of part number

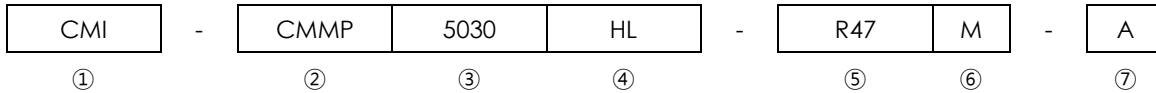

- ① CoilMaster's initial
- ② Series Name : Car Metal Molded Power inductor
- ③ Core Size (unit:mm)
- ④ Type
- ⑤ Typical inductance value (0.47 uH)
- ⑥ Inductance tolerance (±20%)
- ⑦ Revision (A)

Specifications

Part Number	Inductance (uH) ±20%	DCR(mohm) Max.(Typ.)	Isat(A) Max.(Typ.)	Itemp(A) Max.(Typ.)	Test Frequency (Hz)
CMI-CMMP5030HL-R47M-A	0.47	6.6(5.5)	20.0(22.0)	13.5(14.5)	1M
CMI-CMMP5030HL-R68M-A	0.68	8.4(7)	16.5(18.5)	11.0(12.0)	1M
CMI-CMMP5030HL-1R0M-A	1.0	10.2(8.5)	13.5(15.5)	10.5(11.5)	1M
CMI-CMMP5030HL-1R5M-A	1.5	15.6(13)	11.5(13.5)	9.3(10.3)	1M
CMI-CMMP5030HL-2R2M-A	2.2	21.6(18)	10.5(11.5)	7.4(8.2)	1M
CMI-CMMP5030HL-3R3M-A	3.3	30(25)	7.3(8.3)	5.9(6.5)	1M
CMI-CMMP5030HL-4R7M-A	4.7	48(40)	7.0(8.0)	5.2(5.8)	1M
CMI-CMMP5030HL-5R6M-A	5.6	66(55)	6.7(7.7)	4.7(5.2)	1M
CMI-CMMP5030HL-6R8M-A	6.8	72(60)	5.0(5.5)	4.6(5.1)	1M
CMI-CMMP5030HL-100M-A	10	96(80)	4.9(5.4)	3.8(4.2)	1M
CMI-CMMP5030HL-150M-A	15	162(135)	4.5(5.0)	2.3(2.5)	1M
CMI-CMMP5030HL-220M-A	22	204(170)	4.0(4.5)	2.1(2.3)	1M

- Isat: When based on the inductance change rate (approximately 30% below in the initial value)
- Itemp: When based on the temperature increase (Temperature increase of approximately 40°C by self heating)
- Operating Temperature Range(including self temperature) : -40°C ~ +150 °C

Note 1 : Circuit design, component placement, PCB trace size and thickness, airflow and other cooling. Provision all affect the part Temperature. Part temperature should be verified in the end application.

▪ **You can also contact us by e-mail : coilmaster@coilmaster.com**

- All specifications are subject to change without notice.
- Update date : 2023.05.25

www.coilmaster.com

Electrical characteristics

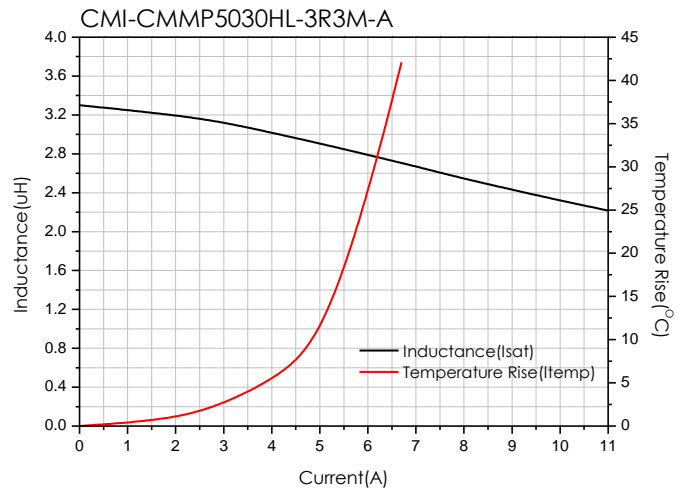
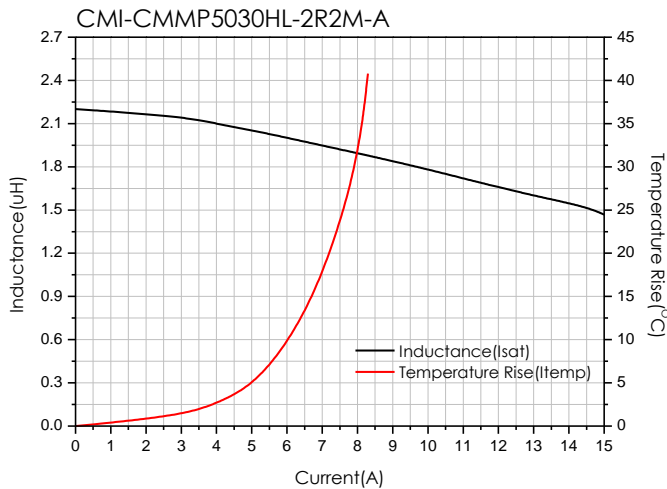
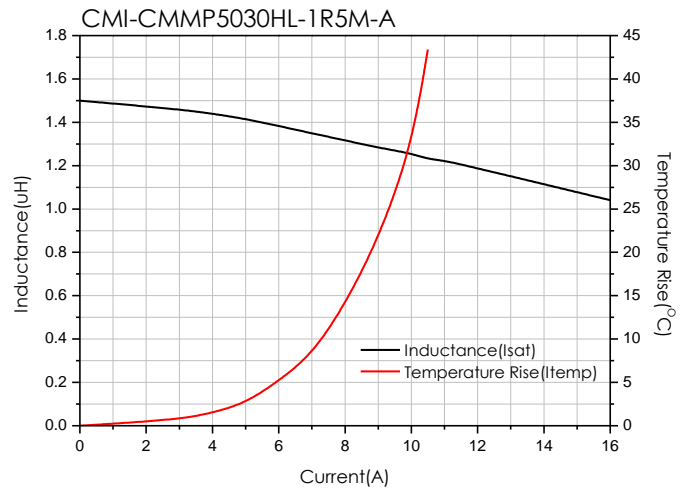
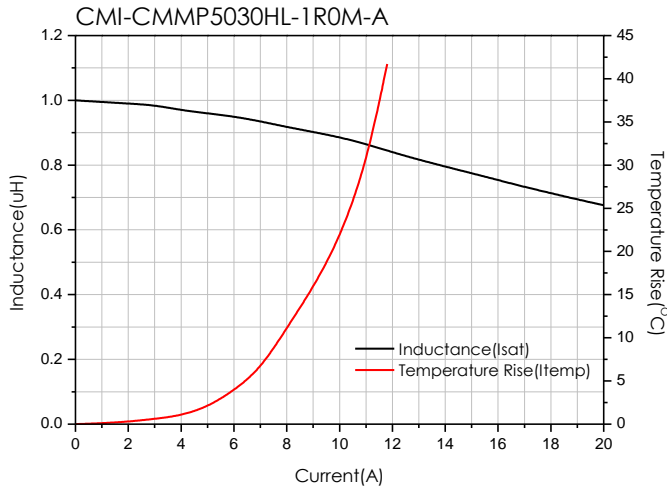
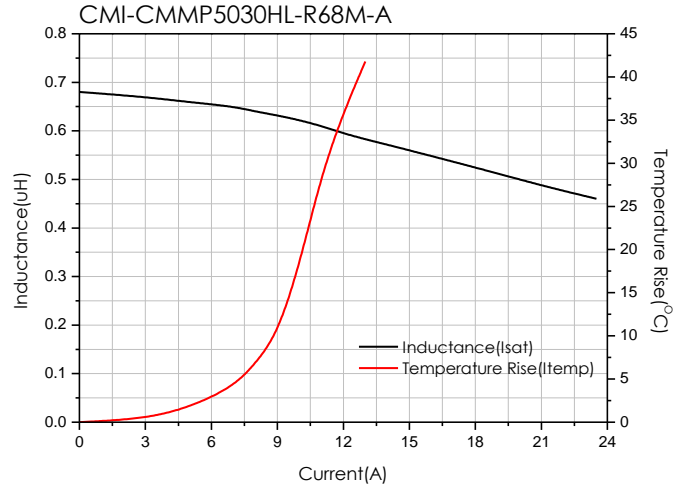
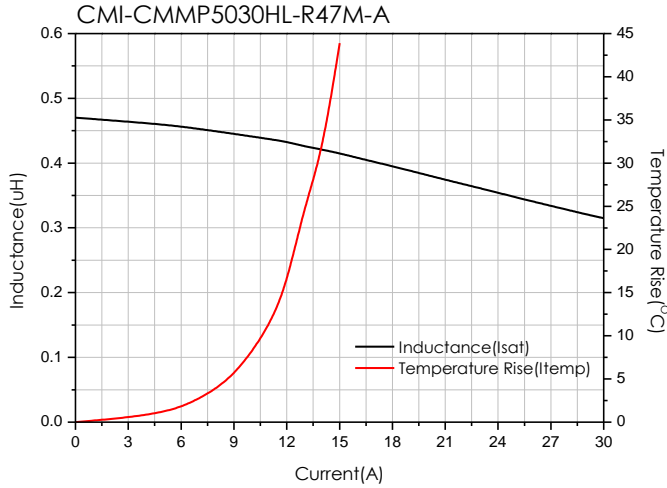

- You can also contact us by e-mail : coilmaster@coilmaster.com
- All specifications are subject to change without notice.
- Update date : 2023.05.25

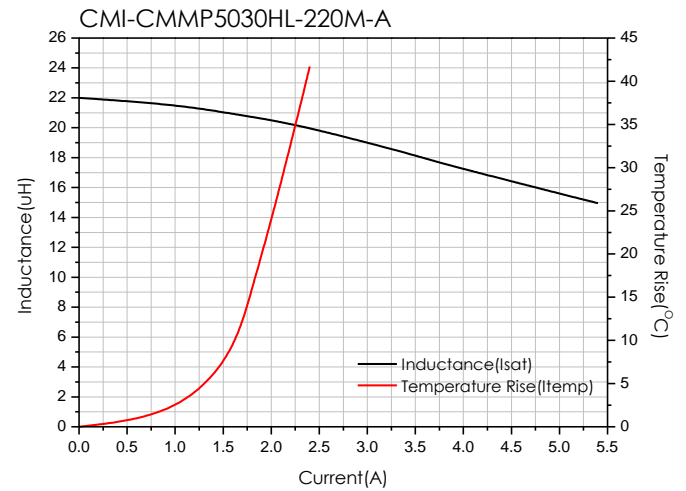
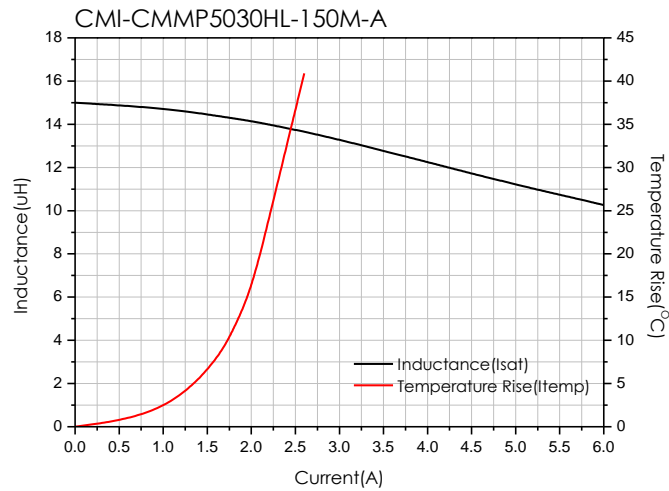
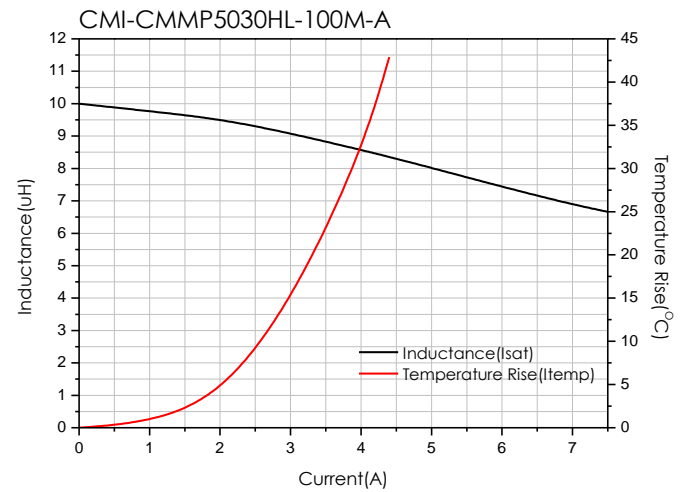
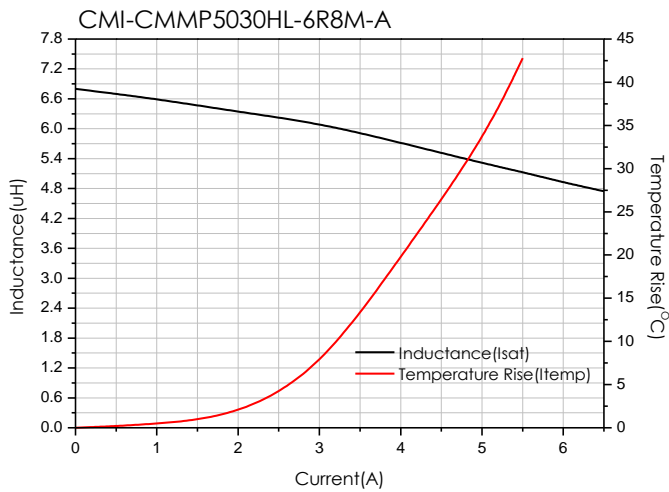
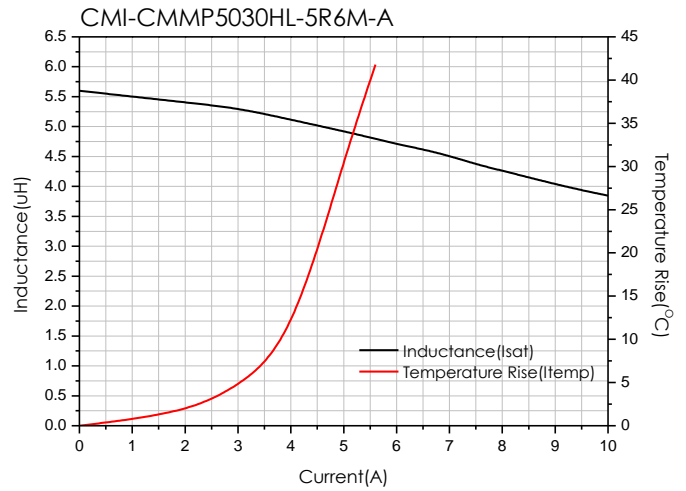
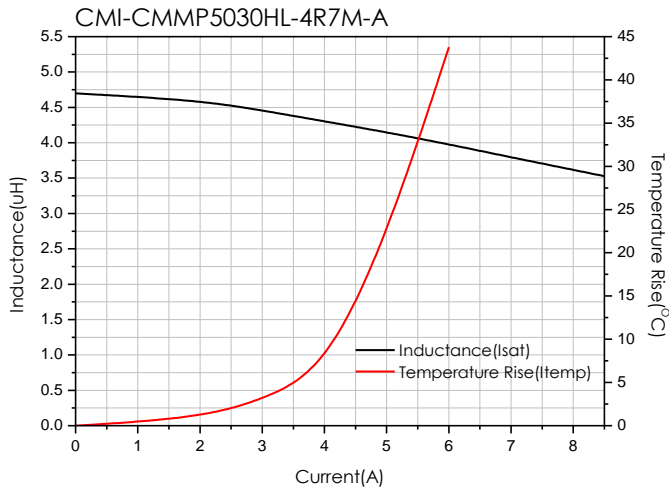

- You can also contact us by e-mail : coilmaster@coilmaster.com
- All specifications are subject to change without notice.
- Update date : 2023.05.25

Packaging

(1) Package quantity : 1,500 (pcs/reel)

(2) Reel Dimensions (unit:mm)

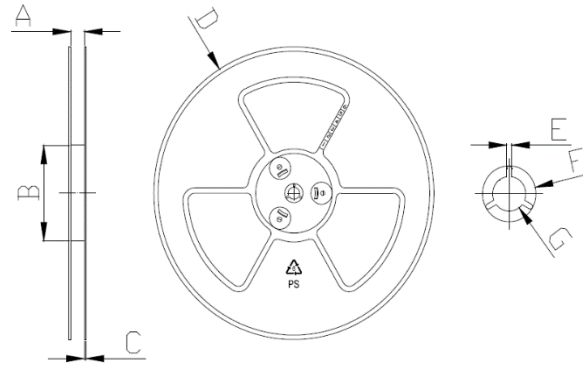

A	B	C	D	E	F	G
12.50	100.0	2.00	330.0	1.90	21.00	13.00
+1.00	+1.50	+0.10	+1.00	+0.40	+0.40	+0.40
-1.00	-1.50	-0.10	-1.00	-0.40	-0.40	-0.40

(3) Tape Dimensions

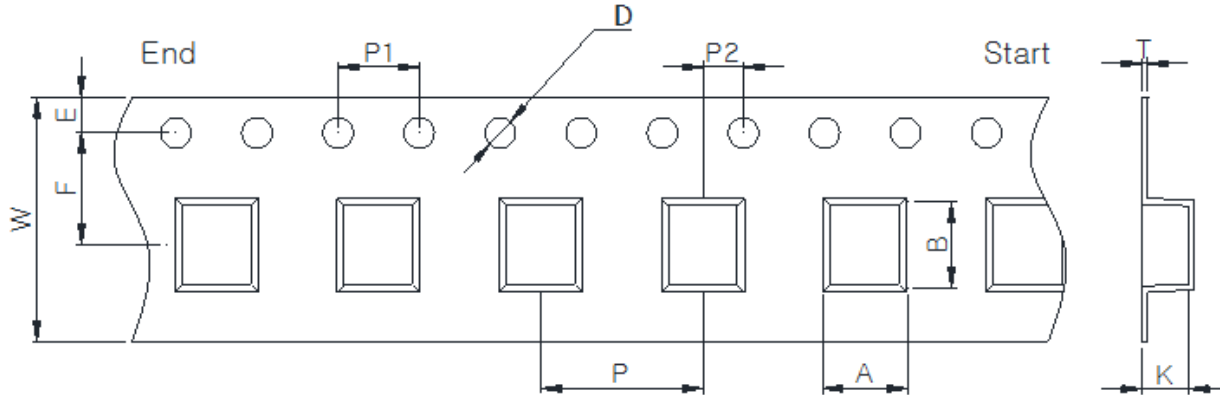

W	A	B	K	E	F	P	P1	P2	D	T
12.00	5.50	5.90	3.10	1.75	5.50	8.00	4.00	2.00	1.50	0.35
+0.30	+0.10	+0.10	+0.10	+0.10	+0.10	+0.10	+0.10	+0.10	+0.10	+0.05
-0.10	-0.10	-0.10	-0.10	-0.10	-0.10	-0.10	-0.10	-0.10	-0.00	-0.05

Korea Sales Office (KOREA) +82)31-904-1444
 China Sales Office (CHINA) +86)0758-683-1444
 Hungary Sales office (EUROPE) +36)1-404-5832

H.K Sales Office (HONGKONG) +852)2711-5551
 LA Sales Office (USA) +1)714-616-6989

• You can also contact us by e-mail : coilmaster@coilmaster.com

- All specifications are subject to change without notice.
- Update date : 2023.05.25

www.coilmaster.com