

CMI-CMMPP12070LL-SERIES

Features

- ▶ High current and low profile
- ▶ Metal powder molding type for EMC protection.
- ▶ Available tape and reel for auto insertion.
- ▶ Halogen-Free / RoHS compliant.
- ▶ AEC-Q200 qualified.

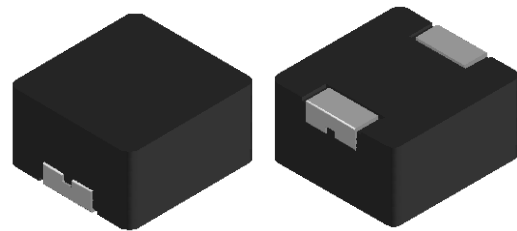

Applications

- ▶ Equipment using for automobiles (ECM, Airbags, Headlights, Electronic Power steering, Motors, ABS, other)

Dimension (Unit:mm)

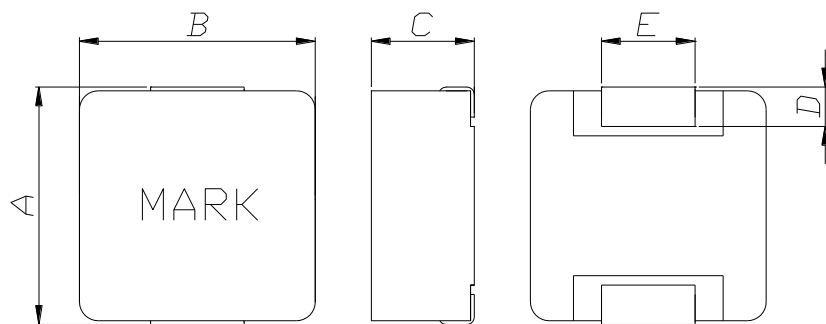

A	B	C	D	E
12.65±0.5	12.6±0.4	7.0 Max	2.0±0.5	5.0±0.2

Land Pattern (Unit:mm)

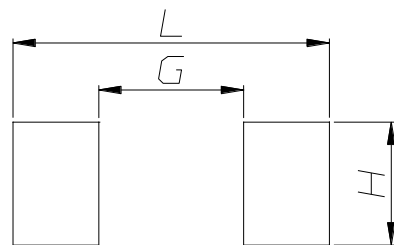

L	G	H
14.2	6.5	5.5

Regulation of part number

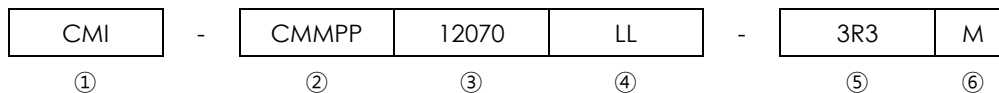

- ① CoilMaster's initial
- ② Series Name : Car Magic Material Pin type Power inductor
- ③ Core Size (unit:mm)
- ④ Material
- ⑤ Typical inductance value (3.3uH)
- ⑥ Inductance tolerance (±20%)

• You can also contact us by e-mail : coilmaster@coilmaster.com
 • All specifications are subject to change without notice.
 • Update date : 2021.12.21

Electrical characteristics

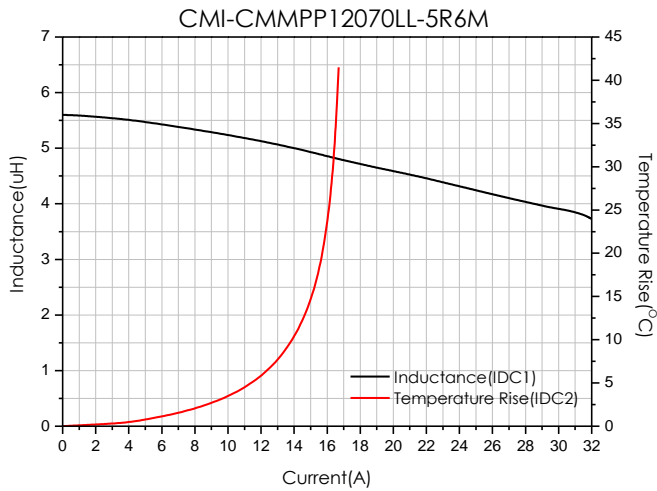
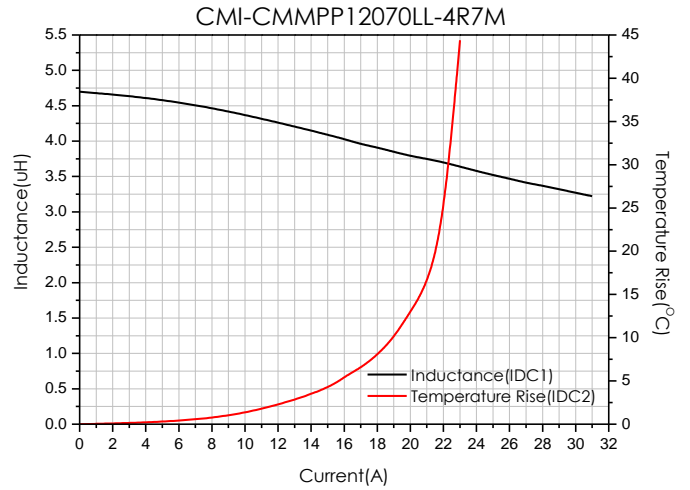
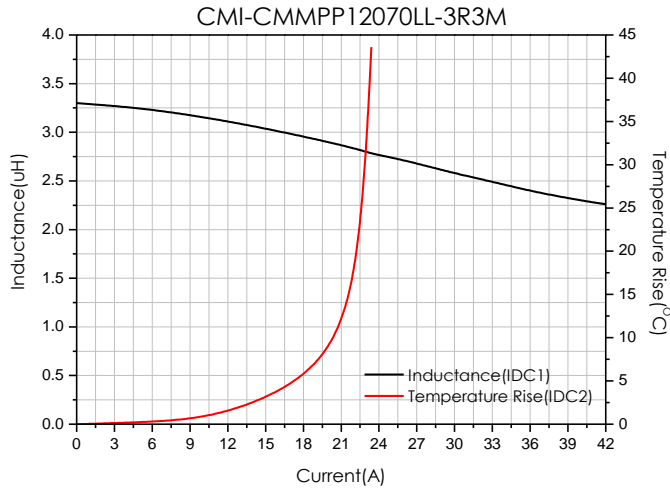

- You can also contact us by e-mail : coilmaster@coilmaster.com
- All specifications are subject to change without notice.
- Update date : 2021.12.21

Packaging

(1) Package quantity : 300 (pcs/reel)

(2) Reel Dimensions (unit:mm)

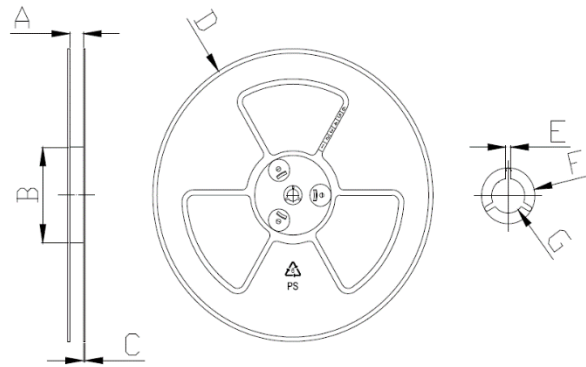

A	B	C	D	E	F	G
24.50	100.0	2.30	330.0	2.30	21.50	13.00
+0.50	+1.00	+0.20	+3.00	+0.30	+0.30	+0.50
-0.50	-1.00	-0.20	-3.00	-0.30	-0.30	-0.20

(3) Tape Dimensions

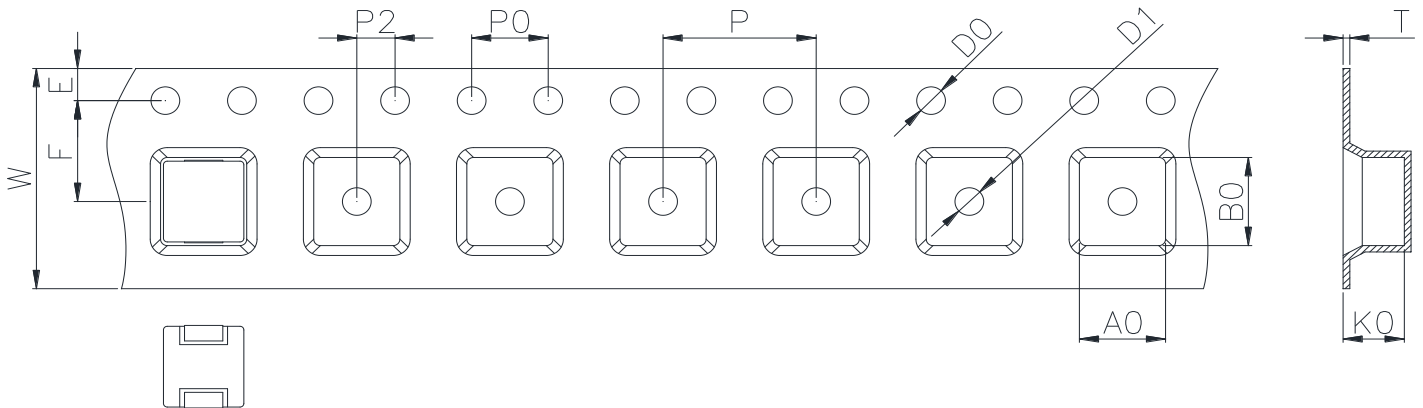

W	A0	B0	K0	E	F	P	P0	P2	D0/D1	T
24.00	13.00	14.20	7.30	1.75	11.50	20.00	4.00	2.00	1.50	0.40
+0.30	+0.10	+0.10	+0.15	+0.10	+0.10	+0.10	+0.10	+0.10	+0.10	+0.05
-0.30	-0.10	-0.00	-0.10	-0.10	-0.10	-0.10	-0.10	-0.10	-0.00	-0.05

Ilson Sales Office (KOREA) +82)31-904-1444
 Shenzhen Sales Office (CHINA) +86)755-8663-6929
 Hungary Sales office (EUROPE) +36)30-913-7706

H.K Sales Office (HONGKONG) +852)2711-5551
 LA Sales Office (USA) +1)866-446-3586

• You can also contact us by e-mail : coilmaster@coilmaster.com

- All specifications are subject to change without notice.
- Update date : 2021.12.21

www.coilmaster.com

- **You can also contact us by e-mail : coilmaster@coilmaster.com**
- All specifications are subject to change without notice.
- Update date : 2021.12.21