

# SMD Power Inductor CEP12D38

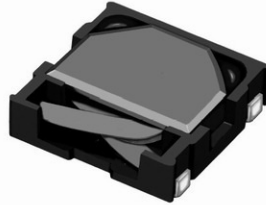

## Description

- Ferrite core construction.
- Magnetically shielded.
- L × W × H: 12.8 × 12.8 × 4.0 mm Max.
- Product weight: 1.83g(Ref.)
- Moisture Sensitivity Level: 1
- RoHS compliance.

## Environmental Data

- Operating temperature range: -40°C~+125°C (including coil's self temperature rise)
- Storage temperature range: -40°C~+125°C
- Solder reflow temperature: 260 °C peak.

## Packaging

- Carrier tape and reel packaging
- 13.0" diameter reel
- 1000pcs per reel

## Applications

- Ideally used in Notebook PC, CPU power supply.

## Dimension - [mm]

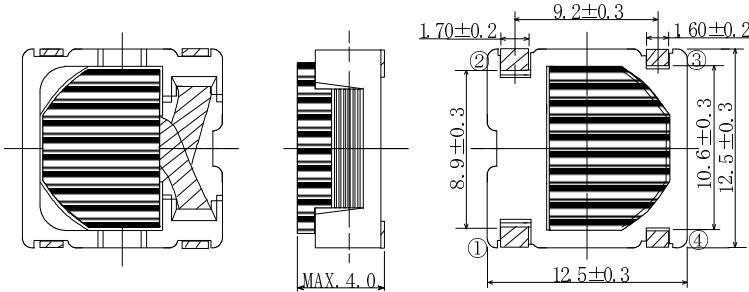

## Land pattern and Schematics - [mm]

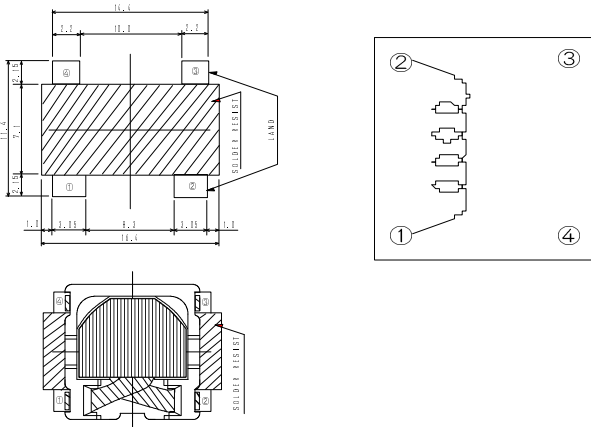

# SMD Power Inductor CEP12D38



## Electrical Characteristics - 1

PART NO.	STAMP	INDUCTANCE [ WITHIN ] ※1	D.C.R. (mΩ) [MAX.] (Typ.) (at 20°C)	SATURATION CURRENT ( A ) ※2		TEMPERATURE RISE CURRENT ( A ) ※3
				(at 20°C)	(at100°C)	
CEP12D38NP-0R6MC-H	0R6MH	0.6 μ H ±20%	6.0(5.0)	24.4	20.0	11.5
CEP12D38NP-1R1MC-H	1R1MH	1.1 μ H ±20%	7.2(6.0)	18.1	14.6	10.0
CEP12D38NP-1R8MC-H	1R8MH	1.8 μ H ±20%	8.6(7.1)	13.9	11.5	9.5
CEP12D38NP-2R6MC-H	2R6MH	2.6 μ H ±20 %	12.1(10.1)	12.2	9.9	8.0

## Electrical Characteristics - 2

PART NO.	STAMP	INDUCTANCE [ WITHIN ] ※1	D.C.R. (mΩ) [MAX.] (Typ.) (at 20°C)	SATURATION CURRENT ( A ) ※2		TEMPERATURE RISE CURRENT ( A ) ※3
				(at 20°C)	(at100°C)	
CEP12D38NP-1R0MC	1R0M	1.0 μ H ±20%	6.0(5.0)	14.8	12.2	11.5
CEP12D38NP-1R8MC	1R8M	1.8 μ H ±20%	7.2(6.0)	11.0	9.0	10.0
CEP12D38NP-2R8MC	2R8M	2.8 μ H ±20%	8.6(7.1)	8.8	7.4	9.5
CEP12D38NP-4R0MC	4R0M	4.0 μ H ±20%	12.1(10.1)	7.2	6.2	8.0

※1. Measuring condition: at 100kHz.

※2. Saturation current: The value of D.C. current when the inductance decreases to 75% of it's nominal value.

※3. Temperature rise current: The value of D.C. current when the temperature rise is  $\Delta t=40^{\circ}\text{C}$  ( $T_a=20^{\circ}\text{C}$ ).

# SMD Power Inductor CEP12D38



## Saturation Current & Temperature Rise Graph

— L (20°C) — L (100°C) —  $\Delta T$

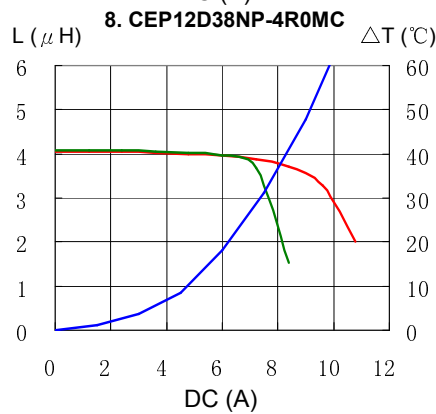
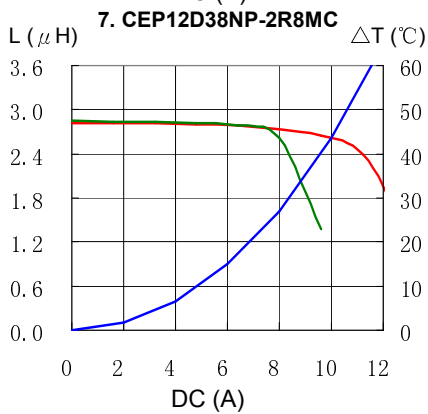
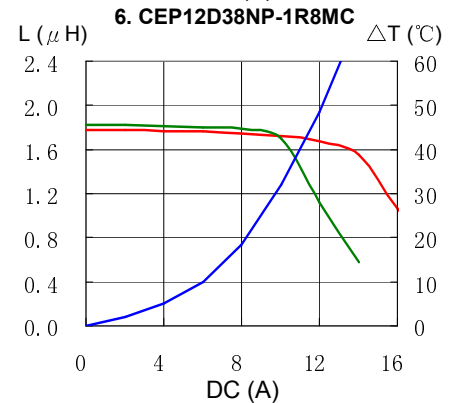
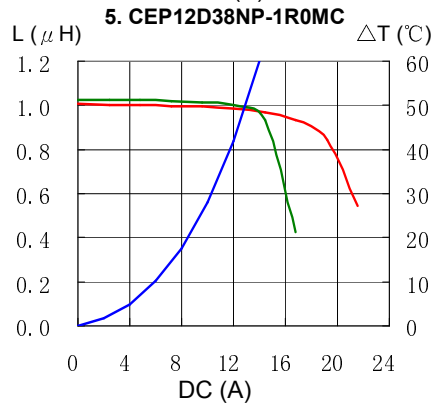
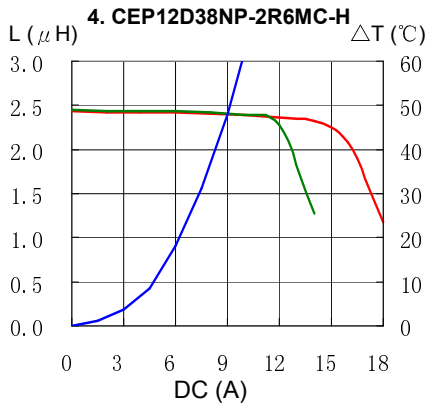
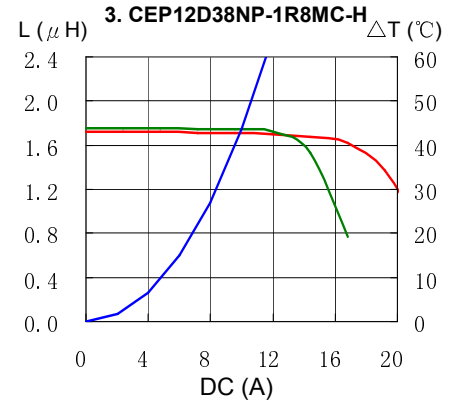
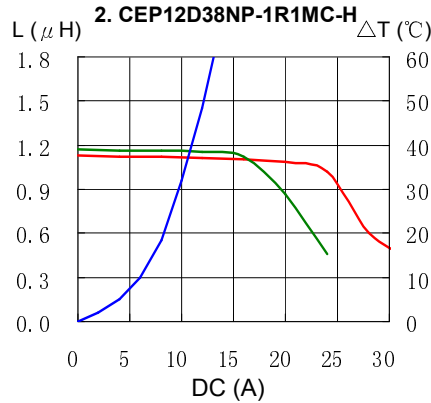
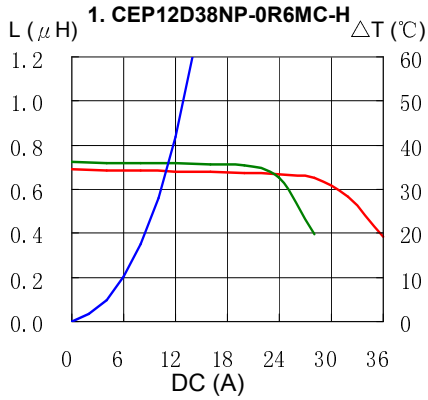

# SMD Power Inductor CEP12D38



## Solder Reflow Condition

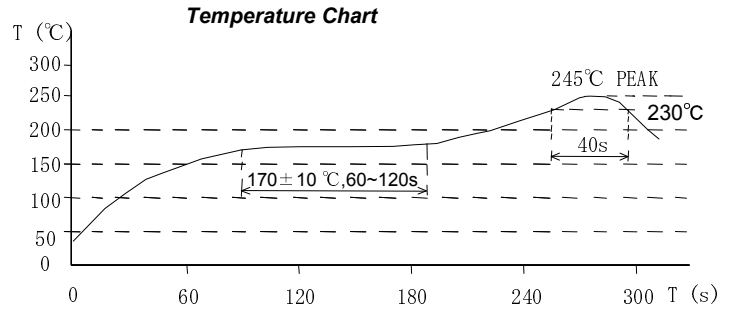
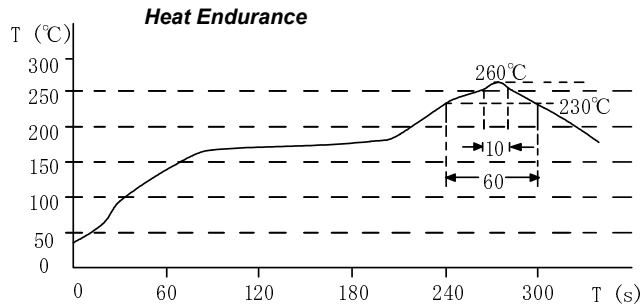

Please refer to the sales offices on our website - <http://www.sumida.com>

### Hong Kong

Tel.+852-2880-6781  
FAX.+852-2565-9600  
[sales@hk.sumida.com](mailto:sales@hk.sumida.com)

### Saitama(Japan)

Tel.+81-48-691-7300  
FAX.+81-48-691-7340  
[sales@jp.sumida.com](mailto:sales@jp.sumida.com)

### Chicago

Tel.+1-847-545-6700  
FAX. +1-847-545-6720  
[sales@us.sumida.com](mailto:sales@us.sumida.com)

### Shanghai

Tel.+86-21-5836-3299  
FAX.+86-21-5836-3266  
[shanghai.sales@cn.sumida.com](mailto:shanghai.sales@cn.sumida.com)

### Seoul

Tel.+82-2-6237-0777  
FAX.+82-2-6237-0778  
[sales@kr.sumida.com](mailto:sales@kr.sumida.com)

### Oberzell

Tel.+49-8591-937-0  
FAX. +49-8591-937-103  
[contact@eu.sumida.com](mailto:contact@eu.sumida.com)

### Shenzhen

Tel.+86-755-8291-0228  
FAX.+86-755-8291-0338  
[shenzhen.sales@cn.sumida.com](mailto:shenzhen.sales@cn.sumida.com)

### Singapore

Tel.+65-6296-3388  
FAX.+65-6841-4426  
[sales@sg.sumida.com](mailto:sales@sg.sumida.com)

### Neumarkt

Tel.+49-9181-4509-110  
FAX. +49-9181-4509-310  
[infocomp@eu.sumida.com](mailto:infocomp@eu.sumida.com)

### Taipei

Tel.+886-2-8751-2737  
FAX.+886-2-8751-2738  
[sales@tw.sumida.com](mailto:sales@tw.sumida.com)

### San Jose

Tel.+1-408-321-9660  
FAX.+1-408-321-9308  
[sales@us.sumida.com](mailto:sales@us.sumida.com)