

SMD Power Inductor CDRH4D16FB

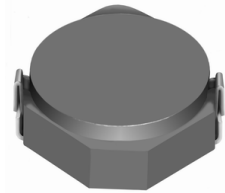

Description

- Ferrite drum core construction.
- Magnetically shielded.
- L × W × H: 4.15 × 4.15 × 1.8 mm Max.
- Product weight: 100mg(Ref.)
- Moisture Sensitivity Level: 1
- RoHS compliance.
- Halogen Free available.

Environmental Data

- Operating temperature range: -40°C~+105°C (including coil's self temperature rise)
- Storage temperature range: -40°C~+105°C
- Solder reflow temperature: 260 °C peak.

Packaging

- Carrier tape and reel packaging
- 7.0" diameter reel
- 1000pcs per reel

Applications

- Ideally used in Mobilephone, PDA, MP3, DSC/DVC, etc. as DC-DC converter inductors.

Dimension - [mm]

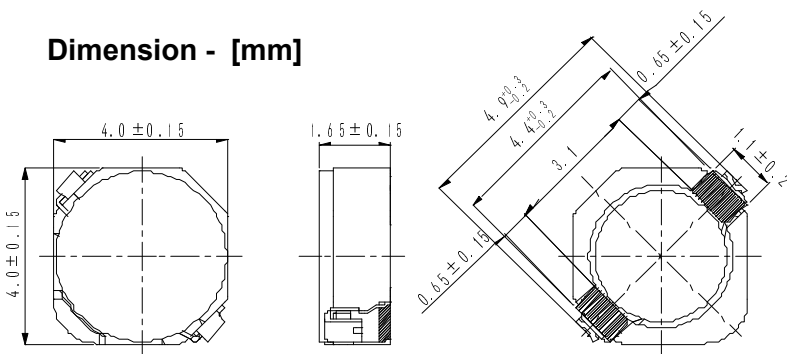

■ ELECTRODE

Land pattern and Schematics - [mm]

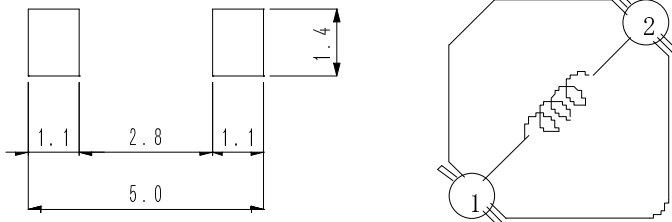

SMD Power Inductor CDRH4D16FB



Electrical Characteristics

Part Name	Stamp	Inductance (μ H) [within] ※1	D.C.R. (m Ω) Max. (Typ.) (at 20°C)	Saturation Current (A) ※2		Temperature Rise Current (A) ※3
				(at 20°C)	(at 100°C)	
CDRH4D16FB/NP-1R3NC	A	1.3 \pm 25%	29.3(22.5)	2.30	1.50	2.8
CDRH4D16FB/NP-1R8NC	B	1.8 \pm 25%	34.5(27.6)	1.90	1.30	2.7
CDRH4D16FB/NP-2R4NC	C	2.4 \pm 25%	37.9(30.3)	1.70	1.20	2.6
CDRH4D16FB/NP-3R0NC	D	3.0 \pm 25%	39.6(31.7)	1.50	1.10	2.4
CDRH4D16FB/NP-3R9NC	E	3.9 \pm 25%	56.7(43.6)	1.35	1.00	2.1
CDRH4D16FB/NP-4R7NC	F	4.7 \pm 25%	58.5(46.8)	1.20	0.90	2.0
CDRH4D16FB/NP-6R8NC	G	6.8 \pm 25%	81.25(65.0)	1.00	0.75	1.5
CDRH4D16FB/NP-8R5NC	H	8.5 \pm 25%	107.0(89.1)	0.90	0.65	1.3
CDRH4D16FB/NP-100MC	J	10 \pm 20%	118.0(98.0)	0.80	0.60	1.2
CDRH4D16FB/NP-150MC	K	15 \pm 20%	178.8(149.0)	0.65	0.50	1.0
CDRH4D16FB/NP-220MC	L	22 \pm 20%	288.0(240.0)	0.52	0.40	0.75

※1. Inductance measuring condition: at 100kHz.

※2. Saturation current: The value of D.C. current when the inductance decreases to 65% of its nominal value.

※3. Temperature rise current: The value of D.C. current when the temperature rise is $\Delta t=40^{\circ}\text{C}$ ($T_a=20^{\circ}\text{C}$).

SMD Power Inductor CDRH4D16FB



Saturation Current & Temperature Rise Graph

— L (20°C) — L (100°C) — ΔT

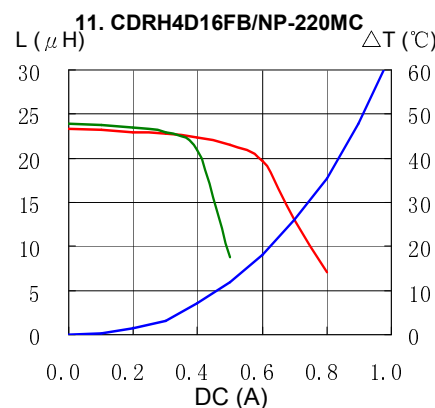
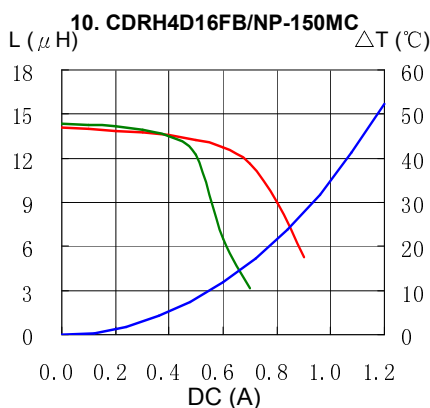
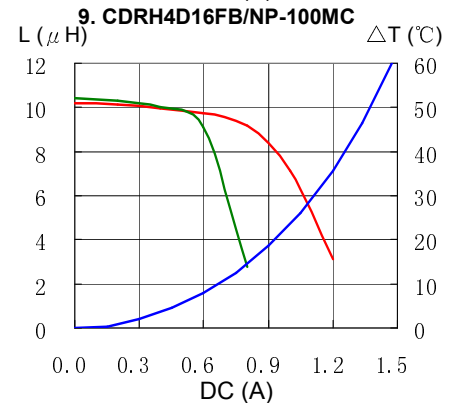
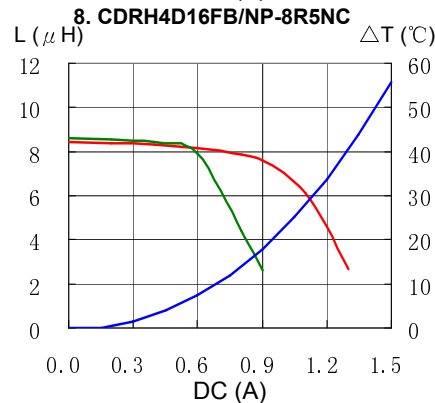
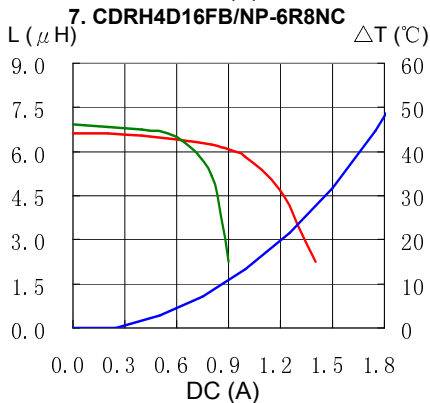
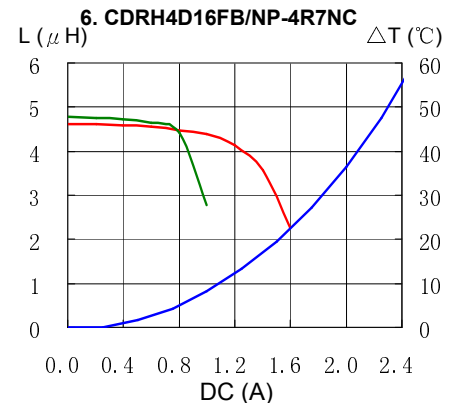
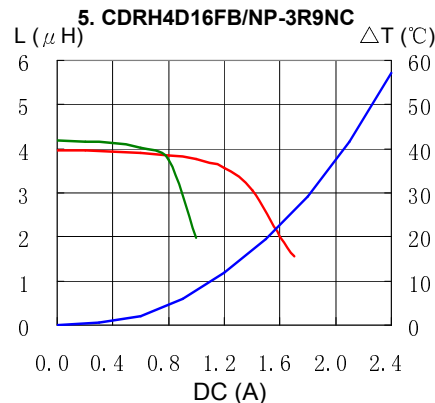
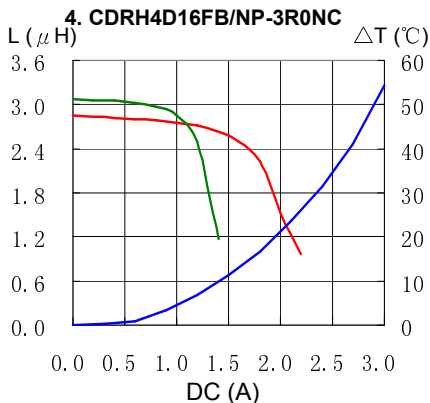
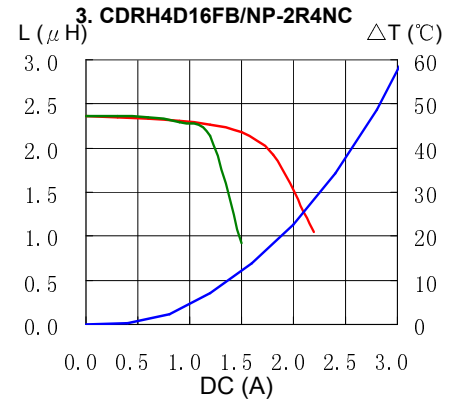
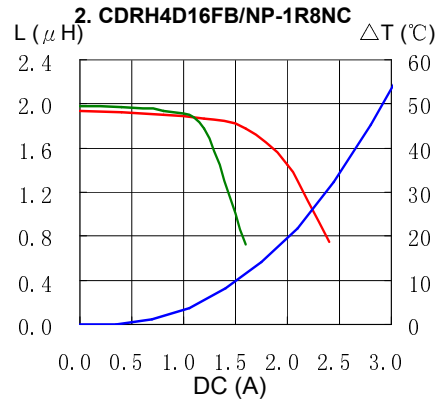
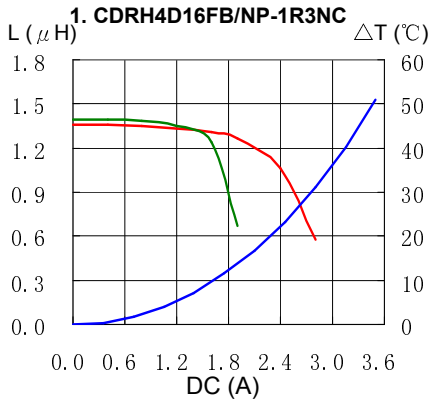

SMD Power Inductor CDRH4D16FB



Solder Reflow Condition

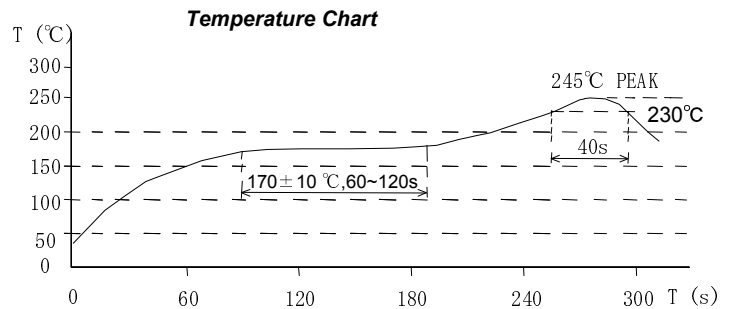
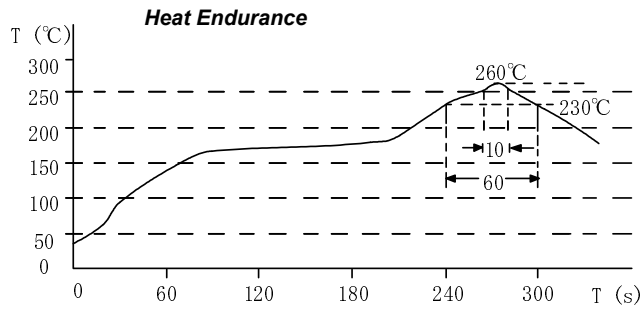

Please refer to the sales offices on our website - <http://www.sumida.com>

Hong Kong

Tel.+852-2880-6781
FAX.+852-2565-9600
sales@hk.sumida.com

Saitama(Japan)

Tel.+81-48-691-7300
FAX.+81-48-691-7340
sales@jp.sumida.com

Chicago

Tel.+1-847-545-6700
FAX. +1-847-545-6720
sales@us.sumida.com

Shanghai

Tel.+86-21-5836-3299
FAX.+86-21-5836-3266
shanghai.sales@cn.sumida.com

Seoul

Tel.+82-2-6237-0777
FAX.+82-2-6237-0778
sales@kr.sumida.com

Oberzell

Tel.+49-8591-937-0
FAX. +49-8591-937-103
contact@eu.sumida.com

Shenzhen

Tel.+86-755-8291-0228
FAX.+86-755-8291-0338
shenzhen.sales@cn.sumida.com

Singapore

Tel.+65-6296-3388
FAX.+65-6841-4426
sales@sg.sumida.com

Neumarkt

Tel.+49-9181-4509-110
FAX. +49-9181-4509-310
infocomp@eu.sumida.com

Taipei

Tel.+886-2-8751-2737
FAX.+886-2-8751-2738
sales@tw.sumida.com

San Jose

Tel.+1-408-321-9660
FAX.+1-408-321-9308
sales@us.sumida.com