

SMD Power Inductor CD105/T125



Description

- Ferrite core construction.
- Magnetically unshielded.
- L × W × H: 10.4 × 9.4 × 5.8mm Max.
- Product weight: 1.3 g(Ref.)
- Moisture Sensitivity Level: 1
- RoHS compliance.
- Qualification to AEC-Q200.

Dimension - [mm]

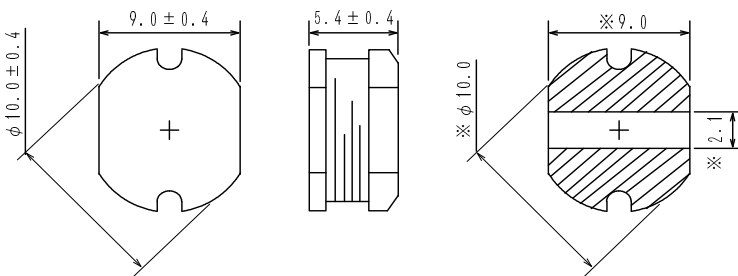

Land pattern and Schematics - [mm]

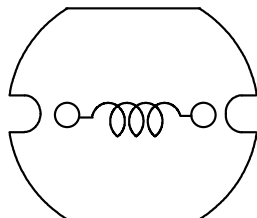
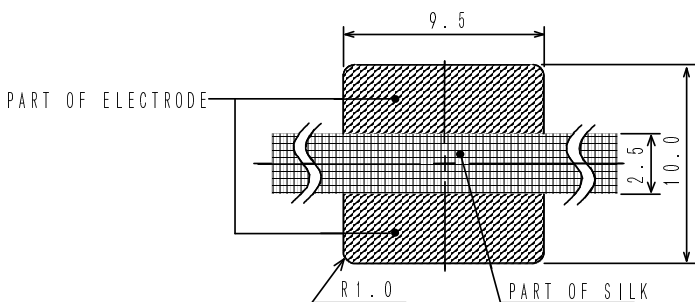

Environmental Data

- Operating temperature range: -40°C ~ +125°C (including coil's self temperature rise)
- Storage temperature range: -40°C ~ +125°C
- Solder reflow temperature: 260 °C peak.

Packaging

- Carrier tape and reel packaging.
- 13" diameter reel
- 500pcs per reel

Applications

- Automotive and other high temperature, high reliability application.

SMD Power Inductor CD105/T125



Electrical Characteristics

Part No.	Stamp	Inductance [Within] (μ H) ※1	D.C.R. (Ω) [Max.] (at 20°C)	Saturation current (A) (at 20°C) ※2	Temperature rise current (A) ※3
CD105T125NP-100MC	100M	10 μ H \pm 20%	0.06	4.00	4.00
CD105T125NP-120MC	120M	12 μ H \pm 20%	0.07	3.54	3.93
CD105T125NP-150MC	150M	15 μ H \pm 20%	0.08	3.17	3.57
CD105T125NP-180MC	180M	18 μ H \pm 20%	0.09	3.00	3.50
CD105T125NP-220MC	220M	22 μ H \pm 20%	0.10	2.66	3.30
CD105T125NP-270MC	270M	27 μ H \pm 20%	0.11	2.45	2.84
CD105T125NP-330MC	330M	33 μ H \pm 20%	0.12	2.20	2.58
CD105T125NP-390MC	390M	39 μ H \pm 20%	0.14	2.02	2.55
CD105T125NP-470KC	470K	47 μ H \pm 10%	0.17	1.92	2.25
CD105T125NP-560KC	560K	56 μ H \pm 10%	0.19	1.81	2.06
CD105T125NP-680KC	680K	68 μ H \pm 10%	0.22	1.65	1.80
CD105T125NP-820KC	820K	82 μ H \pm 10%	0.25	1.50	1.76
CD105T125NP-101KC	101K	100 μ H \pm 10%	0.35	1.31	1.42
CD105T125NP-121KC	121K	120 μ H \pm 10%	0.40	1.22	1.40
CD105T125NP-151KC	151K	150 μ H \pm 10%	0.47	1.10	1.20
CD105T125NP-181KC	181K	180 μ H \pm 10%	0.63	0.99	1.12
CD105T125NP-221KC	221K	220 μ H \pm 10%	0.73	0.89	1.01
CD105T125NP-271KC	271K	270 μ H \pm 10%	0.97	0.81	0.83
CD105T125NP-331KC	331K	330 μ H \pm 10%	1.15	0.72	0.76
CD105T125NP-391KC	391K	390 μ H \pm 10%	1.30	0.63	0.65
CD105T125NP-471KC	471K	470 μ H \pm 10%	1.48	0.60	0.61
CD105T125NP-561KC	561K	560 μ H \pm 10%	1.90	0.56	0.59
CD105T125NP-681KC	681K	680 μ H \pm 10%	2.25	0.52	0.56
CD105T125NP-821KC	821K	820 μ H \pm 10%	2.55	0.48	0.54

※1 Measuring frequency 10 μ H \sim 82 μ H ; at 2.52 MHz
100 μ H \sim 820 μ H ; at 1 kHz

※2 Saturation current: This indicates the actual value of D.C. current when the inductance becomes 10% lower than its initial value.(Ta=20°C)

※3 Temperature rise current: The actual value of D.C. current when the temperature of coil becomes Δ T=40°C (Ta=20°C).

SMD Power Inductor CD105/T125



Saturation Current & Temperature Rise Graph

— L (25°C) — L (105°C) — ΔT

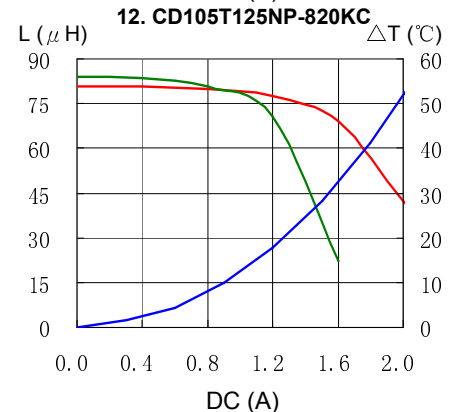
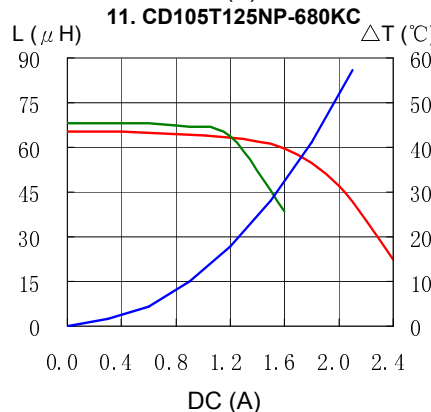
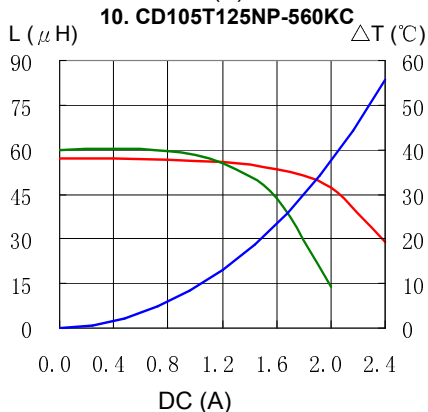
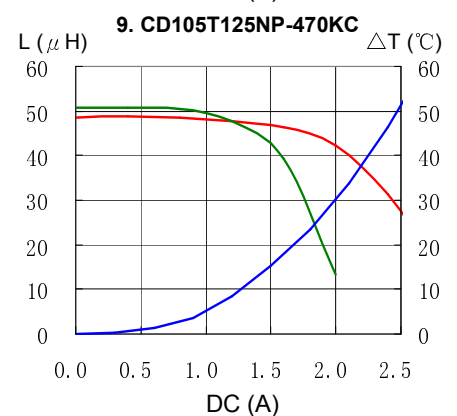
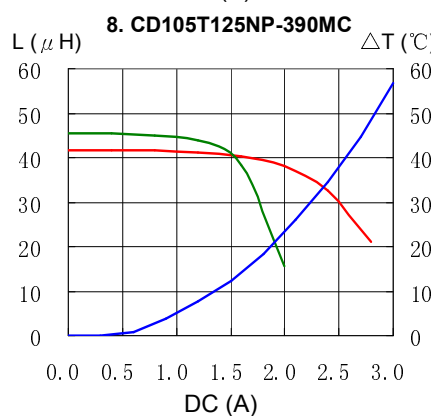
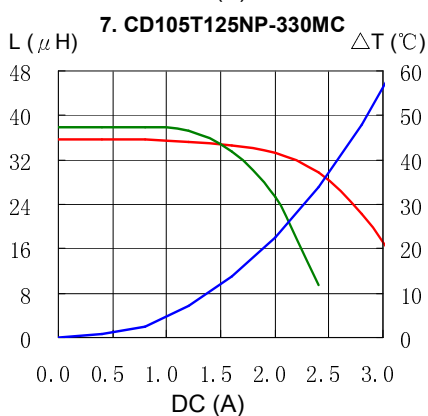
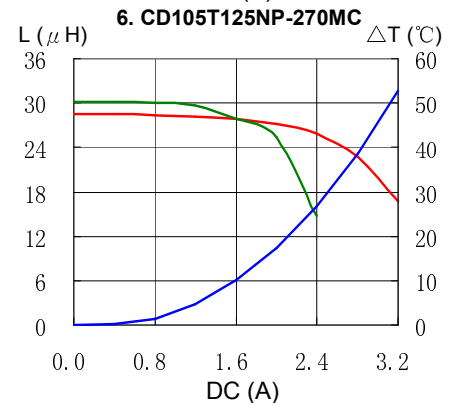
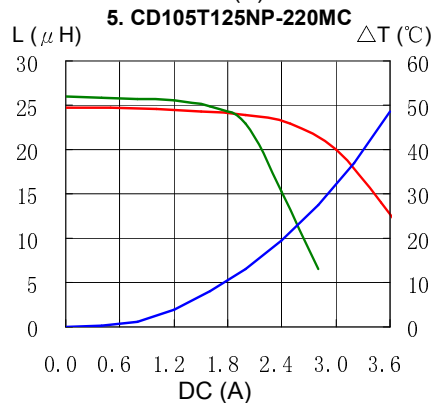
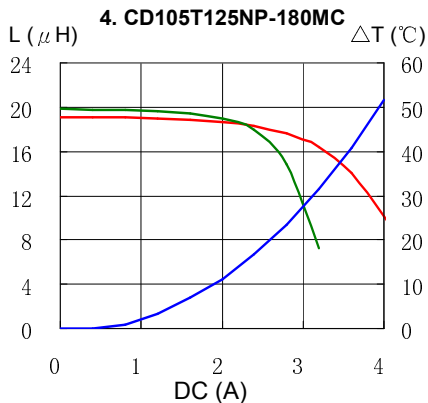
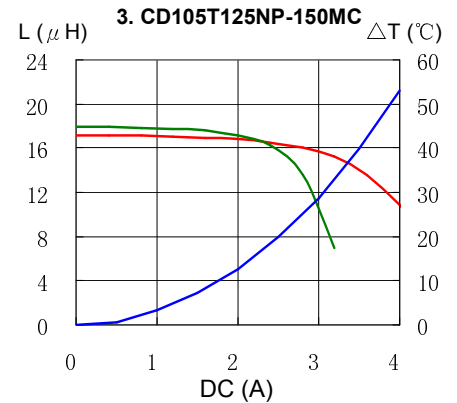
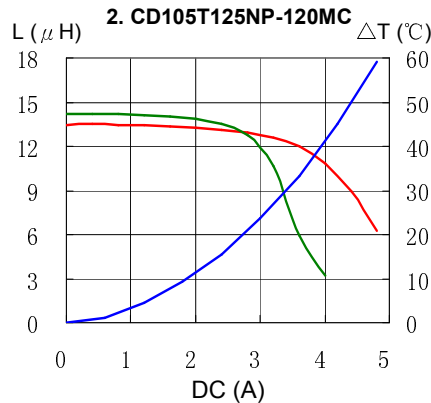
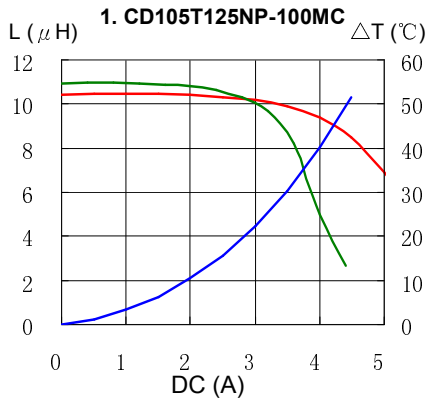

SMD Power Inductor CD105/T125



Saturation Current & Temperature Rise Graph

— L (25°C) — L (105°C) — ΔT

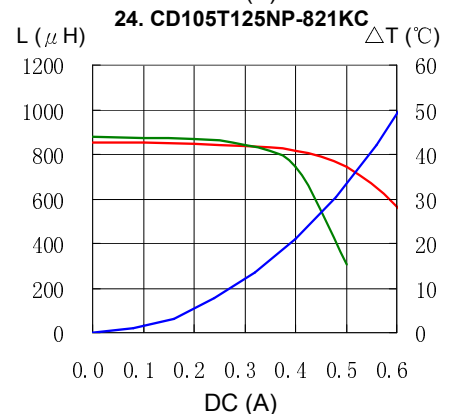
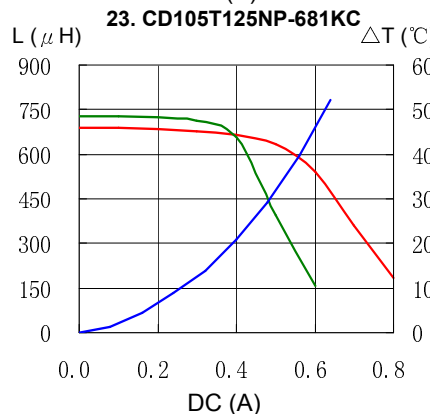
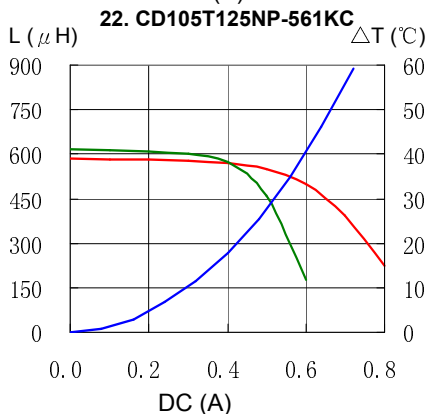
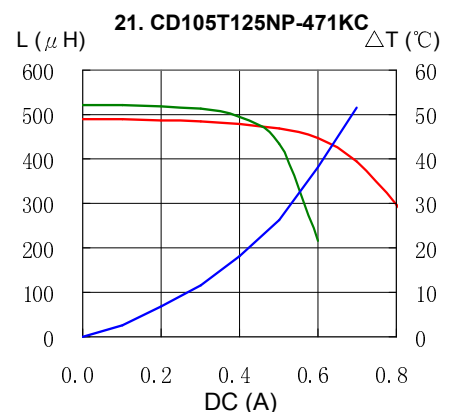
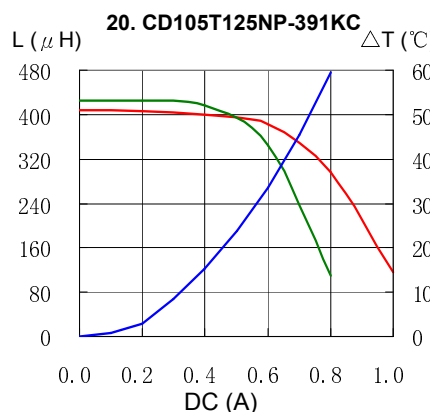
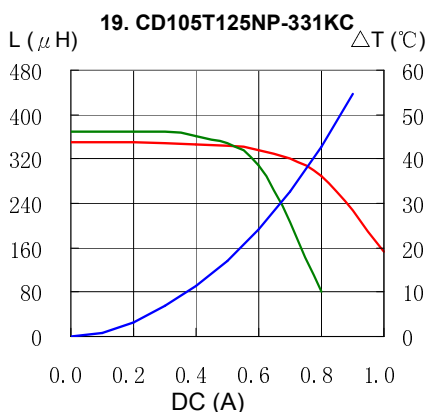
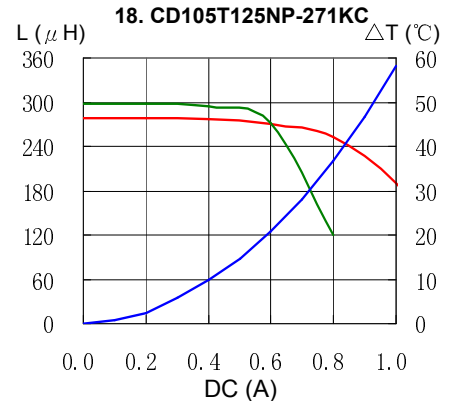
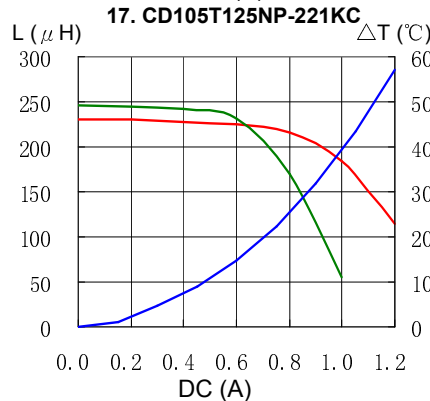
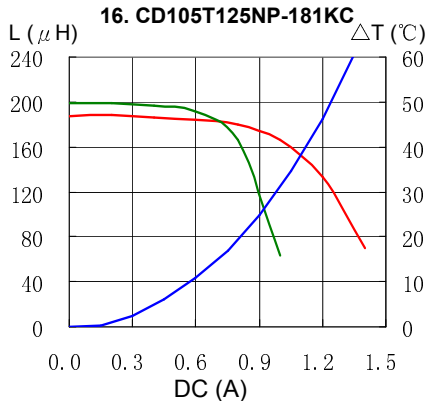
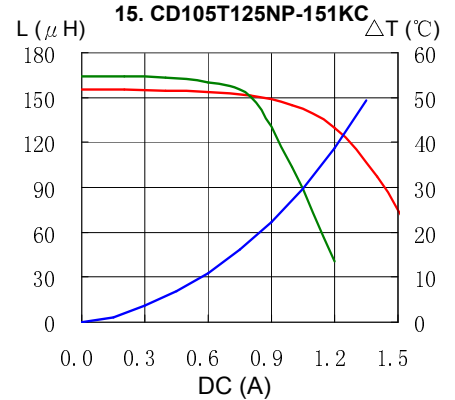
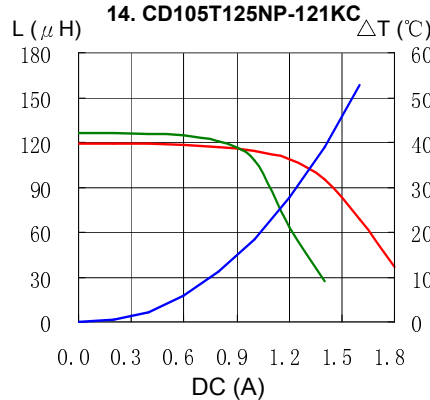
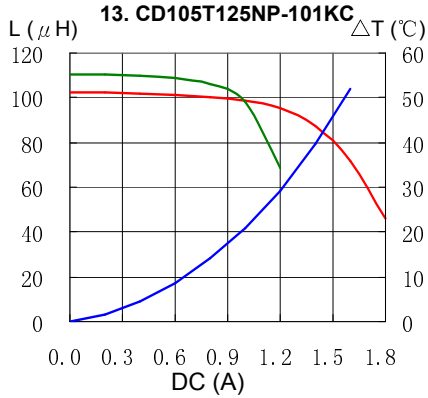

SMD Power Inductor CD105/T125



Solder Reflow Condition

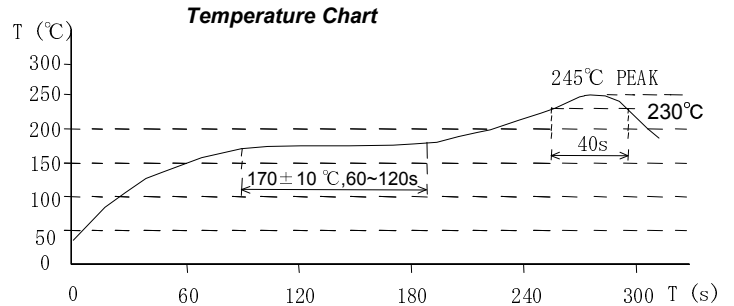
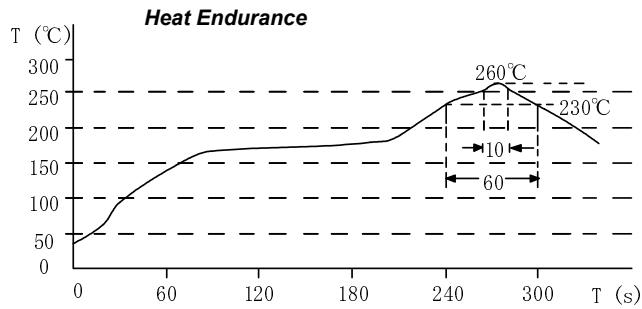

Please refer to the sales offices on our website - <http://www.sumida.com>

Hong Kong

Tel.+852-2880-6781
FAX.+852-2565-9600
sales@hk.sumida.com

Saitama(Japan)

Tel.+81-48-691-7300
FAX.+81-48-691-7340
sales@jp.sumida.com

Chicago

Tel.+1-847-545-6700
FAX. +1-847-545-6720
sales@us.sumida.com

Shanghai

Tel.+86-21-5836-3299
FAX.+86-21-5836-3266
shanghai.sales@cn.sumida.com

Seoul

Tel.+82-2-6237-0777
FAX.+82-2-6237-0778
sales@kr.sumida.com

Oberzell

Tel.+49-8591-937-0
FAX. +49-8591-937-103
contact@eu.sumida.com

Shenzhen

Tel.+86-755-8291-0228
FAX.+86-755-8291-0338
shenzhen.sales@cn.sumida.com

Singapore

Tel.+65-6296-3388
FAX.+65-6841-4426
sales@sg.sumida.com

Neumarkt

Tel.+49-9181-4509-110
FAX. +49-9181-4509-310
infocomp@eu.sumida.com

Taipei

Tel.+886-2-8751-2737
FAX.+886-2-8751-2738
sales@tw.sumida.com

San Jose

Tel.+1-408-321-9660
FAX.+1-408-321-9308
sales@us.sumida.com